

Potain Igo 50

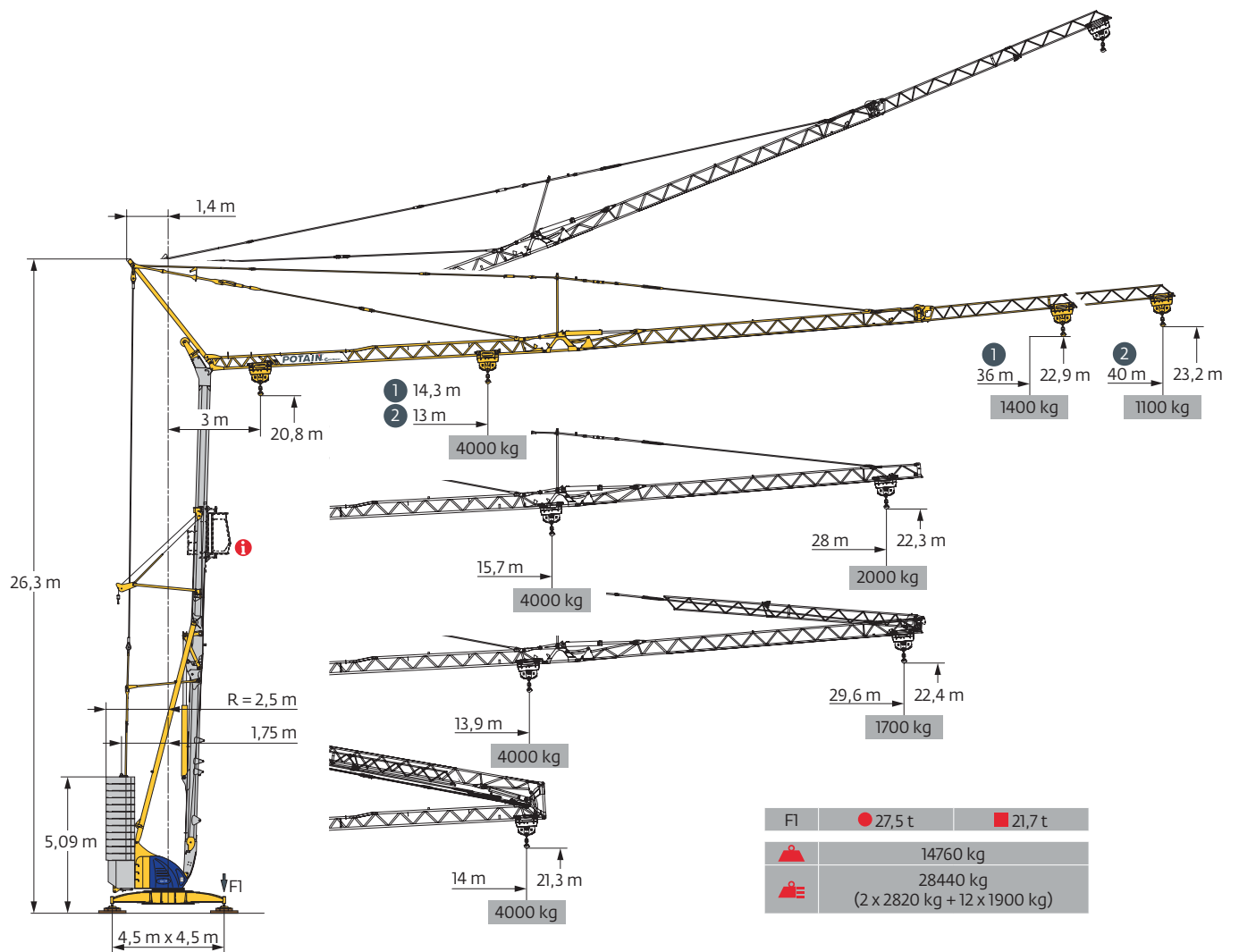

SmartCom

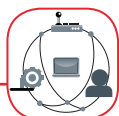

Top Zone

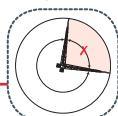

Top Tracing II

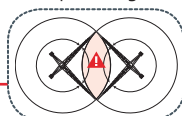

EN 14439 C25-D25
EN 14439 C50-D50
FEM 1.001-A3



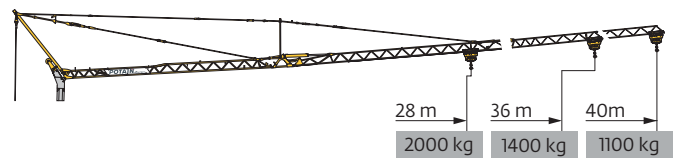

Courbes de charges / Lastkurven / Load curves / Curvas de cargas / Curve di carico
 Curvas de carga / Кривые нагрузок

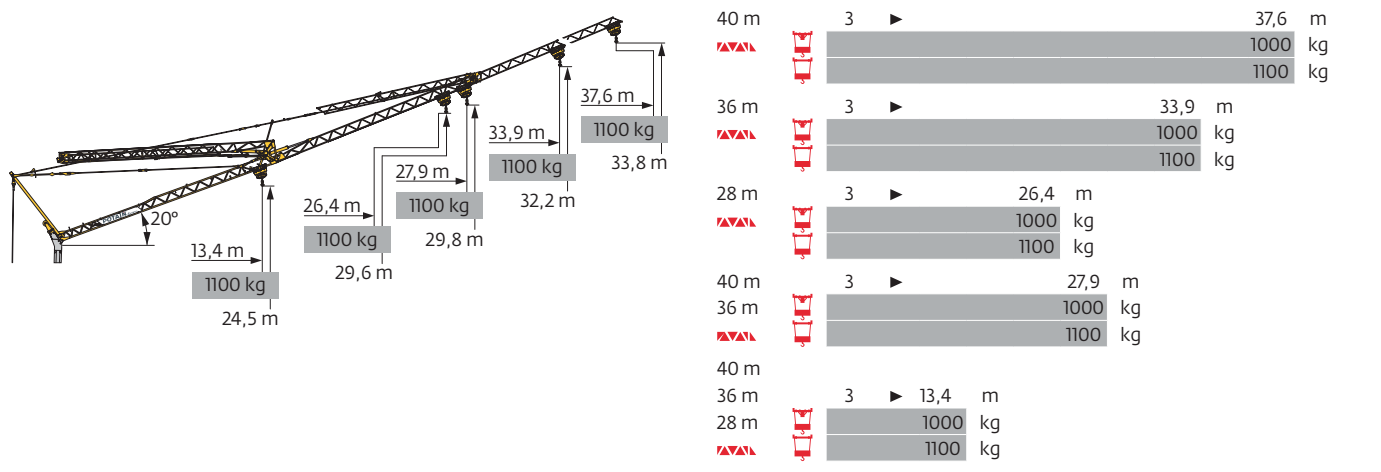
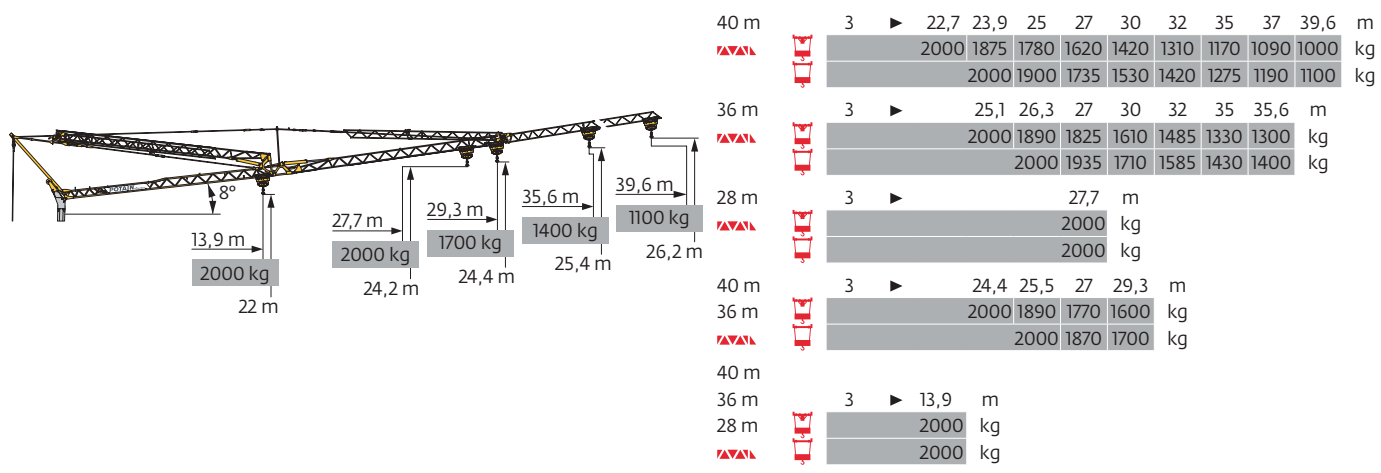
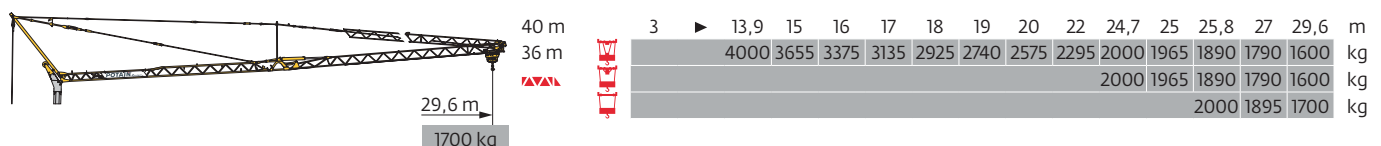



40 m	3	▶	14	m		3	▶	13	14	15	16	17	18	19	20	23	24,2	25	27	30	32	35	37	40	m	
▲▲▲	▲▲▲				4000	kg			4000	3665	3365	3105	2885	2690	2520	2365	2000	1875	1800	1640	1440	1330	1185	1105	1000	kg
					2000	kg											2000	1875	1800	1640	1440	1330	1185	1105	1000	kg
					2000	kg											2000	1920	1755	1550	1435	1290	1210	1100	kg	
36 m	3	▶	14	m		3	▶	14,3	15	16	17	18	19	20	22	24	25,3	26,6	27	30	32	35	36	m		
▲▲▲	▲▲▲				4000	kg			4000	3770	3485	3235	3020	2830	2660	2370	2135	2000	1890	1850	1630	1505	1345	1300	kg	
					2000	kg												2000	1890	1850	1630	1505	1345	1300	kg	
					2000	kg												2000	1960	1735	1610	1450	1400		kg	
28 m	3	▶	14	m		3	▶		15,7	17	18	19	20	22	23	25	26	27	28	m						
▲▲▲	▲▲▲				4000	kg			4000	3635	3395	3180	2990	2670	2530	2290	2190	2090	2000	kg						
					2000	kg														2000	kg					
					2000	kg														2000	kg					



Mécanismes / Triebwerke / Mechanisms / Mecanismos / Meccanismi
 Mecanismos / Механизмы

400 V - 50 Hz 480 V - 60 Hz												ch - PS hp	kW	
	15 LVF 10 Optima	m/min	3,6	18	31	51	66,5	1,8	9	15,5	25,5	33	15	11
		kg	2000	2000	2000	1000	500	4000	4000	4000	2000	1000		
	3 DVF 5	m/min	15 - 30 - 45 (0 → 1000 kg) 15 - 30 - 41 (1000 → 4000 kg)									3	2,2	
	RVF 51 Optima+	tr/min U/min rpm	0 → 0,8									5,5	4	

 IEC 60204-32	kVA
400 V(+10% -10%) 50 Hz / 480 V(+6% -10%) 60 Hz	 → 17 kVA  → 19 kVA

15 LVF 10 Optima

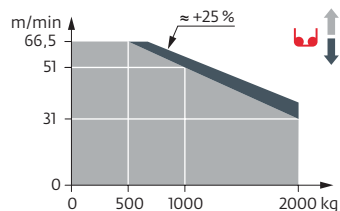

Montage / Montage / Erection / Montaje / Montaggio
 Montagem / Монтаж

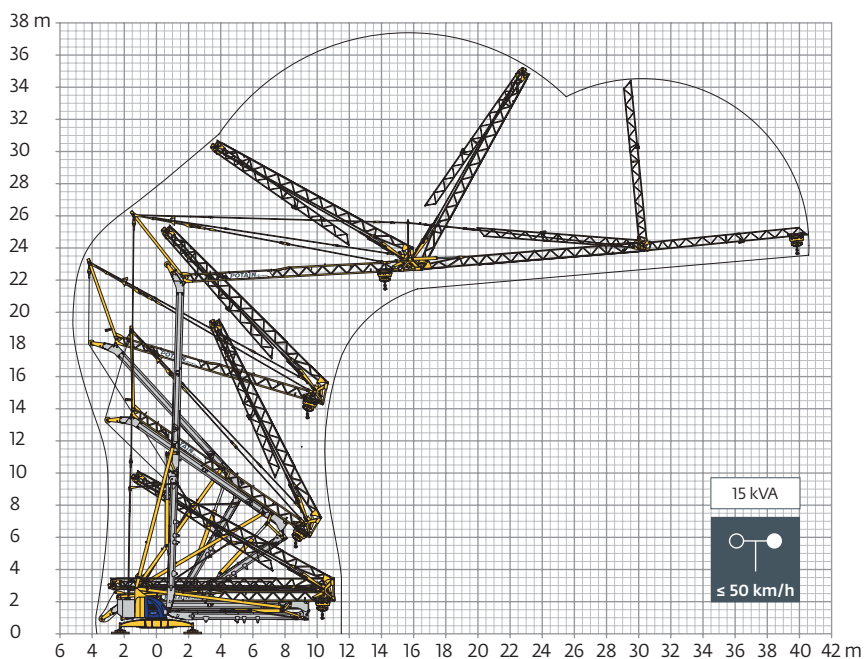

Transport / Transport / Transport / Transporte / Trasporto
Transporte / Транспортировка

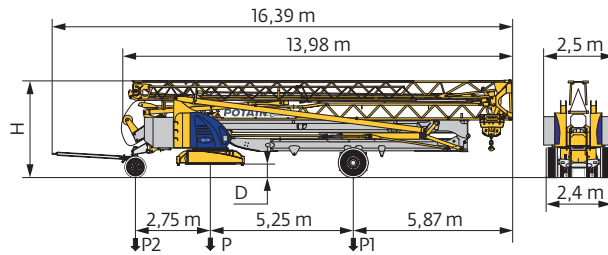

	km/h	D (m)	H (m)	P (kg)	P1 (kg)	P2 (kg)
DJ100/S120	10	0,35/0,2	3,57/3,42	21655	11725	9930
DJ105/S125	25	0,35/0,2	3,57/3,42	21945	11945	10000
..... /..... i						

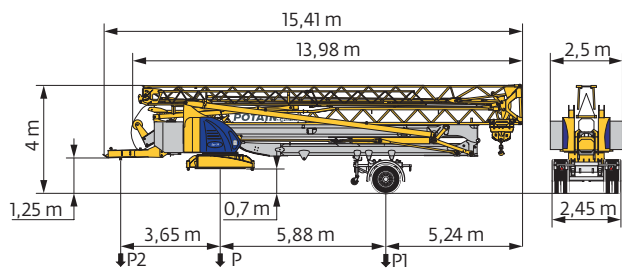

	km/h	P (kg)	P1 (kg)	P2 (kg)
SL121/J135	25	22495	13000	9495
..... /..... i				

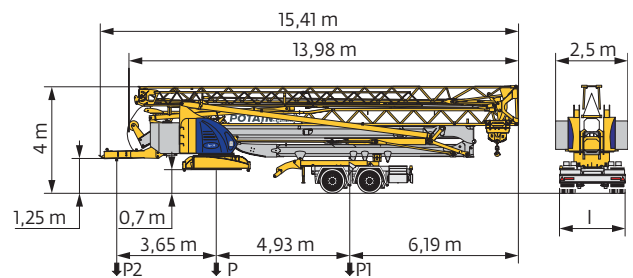

	km/h	l (m)	P (kg)	P1 (kg)	P2 (kg)
SL121/S215M	25	2,4	23740	15490	8250
SL122/J215M	80	2,45	23650	15400	8250
..... /..... i					

FR

- R** Rayon de giration
- i** Nous consulter
- Réactions en service
- Réactions hors service
- ⚖ Poids à vide, sans lest, sans trais de transport, avec flèche maxi. et hauteur standard.
- 📦 Poids total du lest
- 🛠 Équipements standards
- 🔧 Équipements optionnels
- 📏 Levage
- 📍 Distribution
- 🔄 Orientation
- ⚡ Puissance requise

DE

- Schwenk radius
- Auf Anfrage
- Reaktionskräfte in Betrieb
- Reaktionskräfte außer Betrieb
- Gewicht ohne Last, ohne Ballast, ohne Transportachsen, mit max. Auslager und Standardhöhe
- Ballast-Gesamtgewicht
- Standardausrüstungen
- Sonderausrüstungen
- Heben
- Katzfahren
- Schwenken
- Erforderliche Leistung

EN

- Rear slewing radius
- Consult us
- Reactions in service
- Reactions out of service
- Weight without load, without ballast, without transport axes, with max. jib and standard height
- Total ballast weight
- Standard equipment
- Options
- Hoisting
- Trolleying
- Slewing
- Required power

ES

- Radio de giro
- Consultarnos
- Reacciones en servicio
- Reacciones fuera de servicio
- Peso en vacío, sin lastre, sin trenes de transporte con flecha y altura estándar
- Peso total del lastre
- Equipamiento de serie
- Equipamiento opcional
- Elevación
- Distribución
- Orientación
- Potencia Necesaria

IT

- Raggio di rotazione
- Consultateci
- Reazioni in servizio
- Reazioni fuori servizio
- Peso a vuoto, senza zavorra, senza assali di trasporto, con braccio max e altezza standard.
- Peso totale della zavorra
- Equipaggiamento standard
- Equipaggiamento in opzione
- Sollevamento
- Distribuzione
- Rotazione
- Potenza richiesta

PT

- Raio de rotação
- Consultar-nos
- Reacções em serviço
- Reacções fora de serviço
- Peso em vazio, sem lastro, sem eixos de transporte com lança máxima e altura standard.
- Peso total do lastro
- Equipamento de série
- Equipamento opcional
- Elevação
- Distribuição
- Rotação
- Potência Necessária

RU

- Задний габарит
- Проконсультируйтесь у нас
- Реакция при работе
- Реакция в покое
- Вес без груза, без балласта, без осей для транспортировки, с максимальным вылетом стрелы и стандартной высотой
- Общий вес балласта
- Стандартное оборудование
- Дополнительное оборудование (опция)
- Подъем
- Перемещение по стреле
- Поворот
- Потребляемая мощность

⚠ Document commercial non contractuel. Pour toute information technique se référer à la notice correspondante. Unverbindliches Vertriebsdokument. Für technische Informationen, siehe die entsprechenden Anweisungen. This commercial document is not legally binding. For any technical information, please refer to the corresponding instructions. Documento comercial no contractual. Para cualquier información técnica, ver la noticia correspondiente. Documento commerciale non vincolante, per tutte le informazioni tecniche fare riferimento al catalogo istruzioni. Documento comercial não contratual. Para qualquer informação técnica complementar consultar as respectivas instruções. Этот коммерческий документ не является юридически обязательным. Для получения технической информации, см. соответствующие инструкции.



www.manitowoc.com

Americas
Manitowoc, Wisconsin, USA
Tel: +1 920 684 6621
Fax: +1 920 683 6277

Shady Grove, Pennsylvania, USA
Tel: +1 717 597 8121
Fax: +1 717 597 4062

Europe, Middle East, Africa
Dardilly, France
Tel: +33 (0)4 72 18 20 20
Fax: +33 (0)4 72 18 20 00

China
Shanghai, China
Tel: +86 21 6457 0066
Fax: +86 21 6457 4955

Greater Asia-Pacific
Singapore
Tel: +65 6264 1188
Fax: +65 6862 4040